



Enhanced precision in the OR

ARCADIS Orbic/Orbic 3D

Answers for life.

SIEMENS

Discover

new possibilities

Only a few years ago, the ARCADIS® family thoroughly revolutionized intraoperative imaging and opened completely new possibilities. The next ARCADIS generation continues the pace-setting tradition of taking you to a completely new level of clinical excellence.

Focused on improving everyday practice and solely led by the pursuit of highest precision, ARCADIS Orbic incorporates numerous unique solutions for today's clinical demands. From image quality to operability, from versatility to efficiency, the groundbreaking features of ARCADIS Orbic and Orbic 3D set new benchmarks and greatly contribute to maximum operational precision – with outstanding functionalities that make perfect imaging a snap, comprehensive postprocessing features, and an overall ergonomic concept that redefines your clinical workflow.

Discover extensive benefits that put you on the cutting-edge of intraoperative imaging.



Your benefits at a glance

Precise imaging and perfect visualization

Thanks to the optimally matched, fully digital 1K² imaging chain from image acquisition to viewing and archiving and EASY (Enhanced Acquisition System) with automatic dose, contrast and brightness control, ARCADIS Orbic delivers brilliant images in every situation.

Distinctive design and user-friendly operation

Thanks to the counterbalanced, isocentric design of the C-arm and the intelligent color coding for fast and precise positioning, ARCADIS Orbic helps saving time and dose and supersedes readjustments by virtually unlimited projection possibilities with 190° orbital rotation.

Optional intraoperative 3D imaging

With integrated intraoperative 3D imaging, ARCADIS Orbic delivers decisively more safety and precision.

3D Image Fusion for merging 3D data even from different modalities, as well as VRT (Volume Rendering Technique) for highly precise, CT-like visualization and easy orientation in the dataset make intraoperative 3D more efficient than ever before.



Improved clinical workflow

Intraoperative 3D imaging enables intraoperative revisions and evaluation and can replace postoperative CT control.

The ergonomic, lightweight, and compact trolley with 180° rotatable as well as vertically and horizontally adjustable monitors means better maneuverability, less space requirement, and adjustment to every specific need.

The *syngo*® user interface with a Basic/Extended Menu allow for fast and intuitive system operation, image postprocessing, and networking.

Maximum flexibility in data handling

ARCADIS Orbic supports virtually all DICOM 3.0 functionalities and delivers almost unlimited options for postprocessing, archiving, and documentation with CD, DVD, and USB.

Truly digital navigation

ARCADIS Orbic provides NaviLink™, an integrated digital 1K² navigation interface, that is compatible with the navigation systems of all leading manufacturers.

How to relax at imaging and concentrate on surgery

How to ...

Perfectly thought-out and fully digital for outstanding image quality

No matter what the task is, you see what you want to see – in excellent quality and as easy as possible for a broad range of applications like orthopedics, trauma and spine surgery, pain management, and a multitude of other clinical fields. With its ideally matched components, it consistently delivers brilliant images. Its fully digital 1024 x 1024 (1K²) imaging chain begins right at acquisition with its advanced Mu-metal shielded image intensifier and comprises lossless processing, visualization, documentation, and DICOM communication. With its extra-high capacity and its high-resolution digital imaging chain, ARCADIS Orbic is setting standards for mobile C-arms.

Isocentric design makes the difference

Unlike conventional intraoperative imaging systems, ARCADIS Orbic comes with an isocentric C-arm – a unique feature that significantly contributes to clinical efficiency and dose savings. The isocentric design of the C-arm makes readjustments a thing of the past, especially for examinations that require different projections (e.g., distal locking of long-bone fractures with a.p. and lateral x-ray). Moreover, ARCADIS Orbic is capable of full 190° orbital movement with 95° overscan, which yields maximum flexibility in positioning. Virtually any conceivable projection can be performed without any vertical or horizontal readjustment. Above all that, C-arm isocentricity paves the way for intraoperative 3D imaging, which delivers the decisive plus in control and certainty during operations, supersedes postoperative CT in most cases, and is optionally available for ARCADIS Orbic systems.

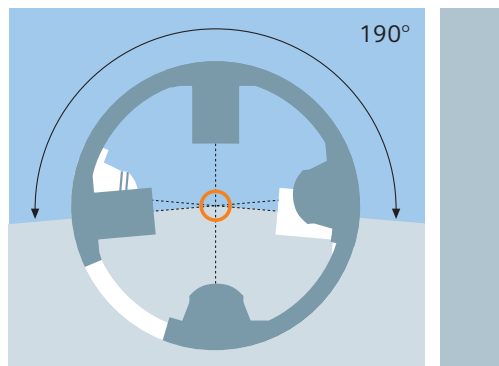
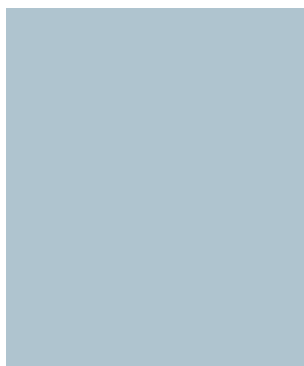
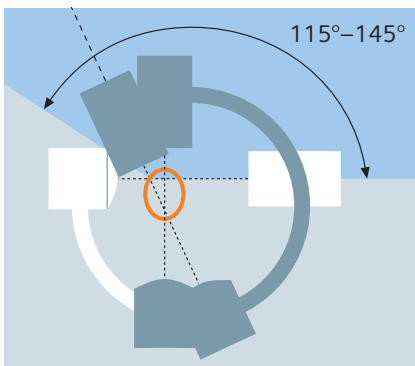

Non-Isocentricity

- The central beam moves out of the isocenter, making repositioning necessary. Repositioning of the C-arm is time-consuming and can lead to additional radiation exposure.
- The distance between the image intensifier or x-ray tube and the body region being imaged varies with each change of the orbital angle. The image size thus varies for different projections.
- The orbital movement is restricted to 25° to 55° degrees of "overscan", depending on C-arm model and manufacturer.

Isocentricity

- The central beam always remains in the isocenter, which eliminates the need for repositioning and enables both time and dose savings.
- The distance between the image intensifier or x-ray tube and the body region being imaged always remains the same, thus ensuring a constant image size with varying projections.
- Large orbital rotation of up to 190° (+95°/-95°).
- Prerequisite for 3D imaging via orbital movement.



concentr



ate



relax

How to make intraoperative imaging a snap

High performance for demanding applications

The powerful imaging hardware of ARCADIS Orbic puts enough power at your fingertips to keep you perfectly prepared for virtually any application. Its tube allows for currents up to 23 mA and for over 50 minutes of fluoro time. At the touch of a button, the enhanced “Power Mode” provides the extra energy required for demanding applications like imaging the lumbar spine.

Intraoperative imaging has never been easier

ARCADIS Orbic comes equipped with EASY (Enhanced Acquisition System), a bundle of automatic image processing features that make intraoperative imaging easier than ever before. Thanks to EASY, ARCADIS Orbic automatically analyzes the images during acquisition to optimize dose, brightness, and contrast. Even off-center objects are now displayed with excellent clarity. This means a great contribution to an intuitive and smooth workflow and will surely redefine the way you work.

Demanding applications, e.g., imaging of dense body regions, can easily be accomplished in enhanced “Power Mode”

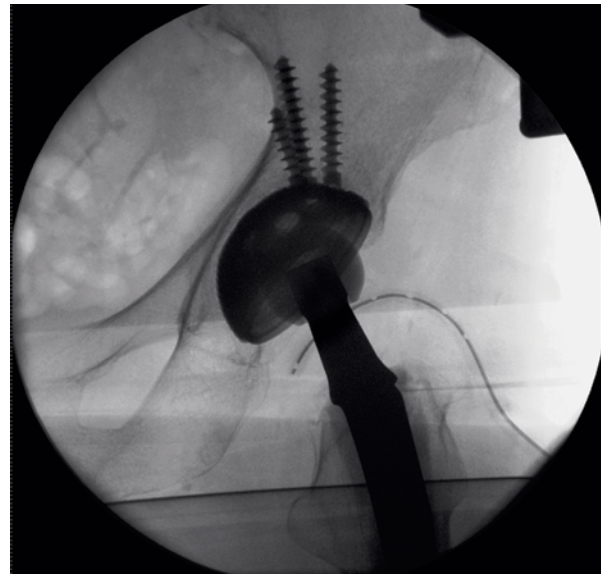
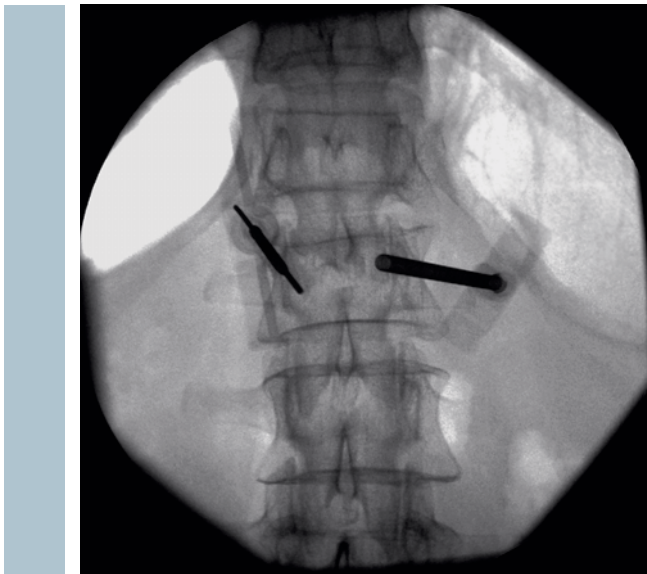

Uncompromising performance throughout the imaging chain

Superior acquisition on one side of the imaging chain demands perfection in visualization on the other side to reveal its full potential. This is why ARCADIS Orbic is equipped with two dedicated medical TFT displays that deliver flicker-free visualization on large 19" screens at high contrast and brightness. With an extraordinarily wide viewing angle of 170° and a highly ergonomic mounting on

the trolley, the monitors adapt to any situation and specific requirement. The displays are available in color or in a monochrome version for extra brightness. And for all those who want even more, ARCADIS Orbic features a practical monitor-out function to connect external monitors, e.g., ceiling-mounted monitors.

EASY assures outstanding imaging results even with off-center objects



Dedicated medical TFT displays with outstanding luminosity for brilliant, flicker-free visualization



How to apply ergonomic solutions and obtain maximum results

How to ...

Ingenious features to support your workflow

ARCADIS Orbic knows what you need and what is important during examinations, because the operational concept of ARCADIS Orbic is entirely workflow-based, and the system was designed with a priority on ease of use and ergonomics.

Quick system navigation with Task Cards

With its unique Task Cards, ARCADIS Orbic puts all control elements you need at your fingertips right from the start. The Task Cards offer a Basic Menu with easy user-guidance for fastest orientation and operation. Whenever needed, you can switch to an Extended Menu that delivers additional information and control elements with a single mouse click.

Simply click and go ahead

The Examination Task Card provides you with a large range of medical applications. The specific programs are intuitively selected using VPA (Virtual Patient Anatomy). Simply click on the VPA body region to be examined to select the appropriate application program optimized to perform the task. Up to 200 dedicated, application-specific programs are available.

Advanced footswitch operability

The multifunction footswitch, which is available as an alternative to the standard footswitch, enables even more user-friendly and intuitive operation of ARCADIS Orbic. It allows surgeons as well as OR staff to control all operating modes and single image storage. Thanks to the adjustable footswitch setup, pulsed fluoroscopy instead of continuous fluoroscopy can be allocated to a fixed pedal – an easy way to further improve dose saving measures and efficient tube load management.

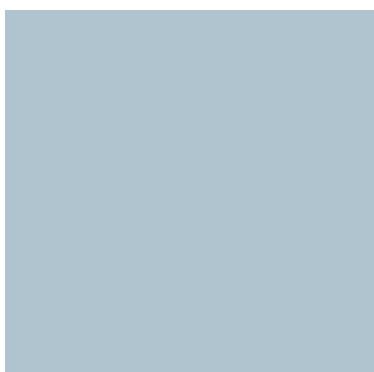
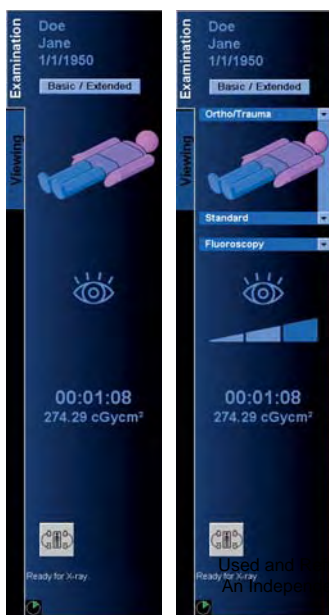

Basic and Extended Task Card menus: additional information and controls at a single mouse click



The multifunction footswitch enables more user-friendly and flexible operation

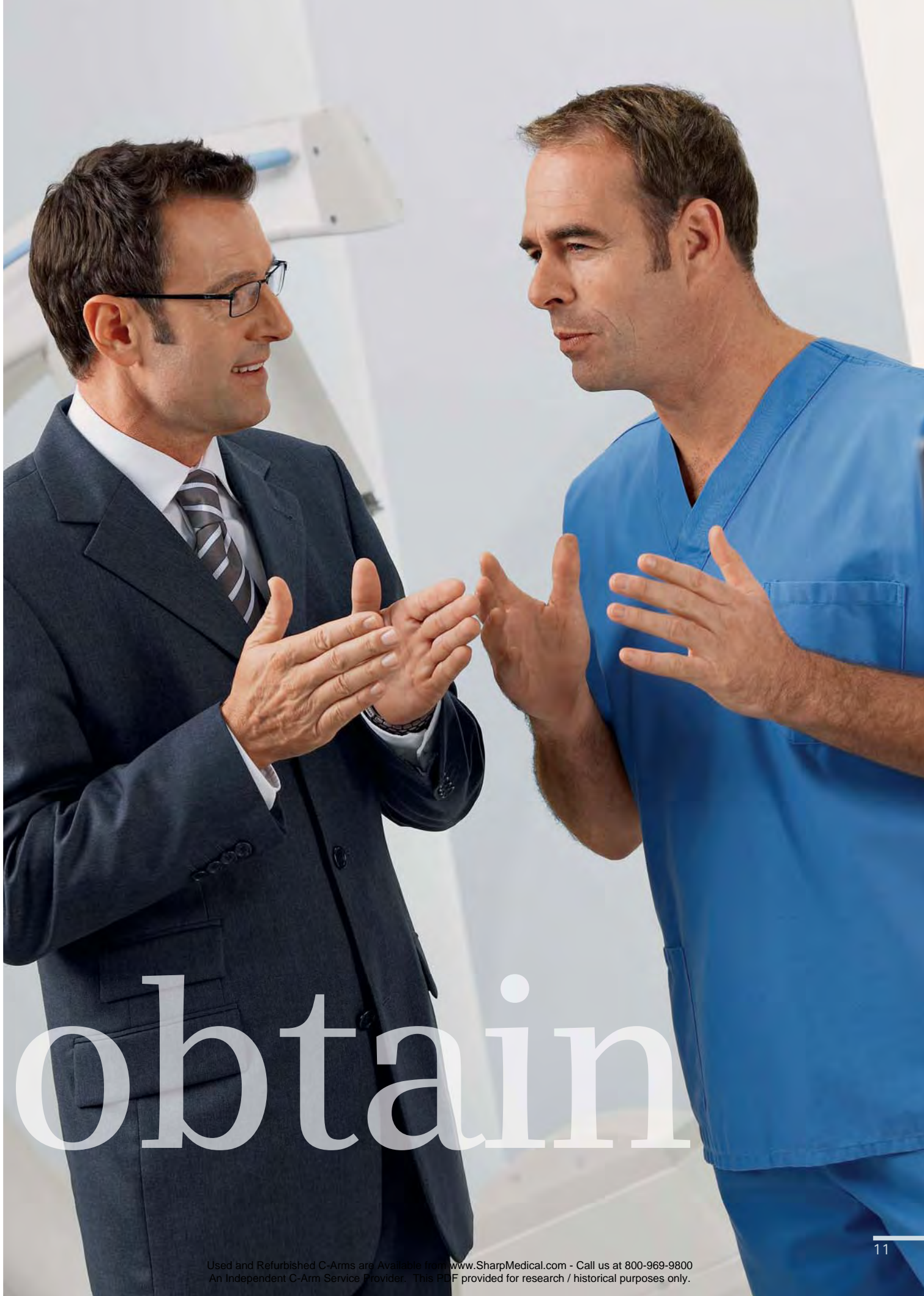

obtain

Forget the light box

Equipped with a fully functional multi-modality workstation, ARCADIS Orbic provides you with the image information you need before, during, and after the OR procedure. Multi-modality viewing allows you to access images from other modalities, such as CT and MR, whenever you need them, while *syngo* enables intuitive and easy handling.

Workflow-oriented throughout with *syngo*

With its *syngo* user interface, ARCADIS Orbic enables intuitive system operation from registration through examination and postprocessing to documentation and archiving. The self-explanatory icons make all the image postprocessing capabilities of *syngo* available to your OR staff with ease. Thanks to *syngo*, ARCADIS Orbic also offers comprehensive connectivity with other modalities and clinical networks irrespective of the manufacturer, and it supports virtually all DICOM functionalities, including DICOM Send/Receive, Storage Commitment, Print, Worklist, Query/Retrieve, and MPPS. This means maximum flexibility from patient registration through postprocessing to archiving and documentation – a substantial improvement of the daily routine.

Flexibility in data storage

ARCADIS Orbic supports off-line data storage of images in DICOM format on CD, DVD, or even on a USB memory stick in DICOM or Bitmap. Using DVDs, the built-in DVD burner allows you to store six times as much as will fit on a standard CD. This is especially useful with patients that require multiple 3D scans in one procedure, as all scans will now fit on one single medium. Moreover, ARCADIS Orbic automatically includes a comprehensive *syngo* DICOM Viewer on every CD and DVD. The images stored on the medium can thus be viewed on every computer, regardless of operating system and platform.

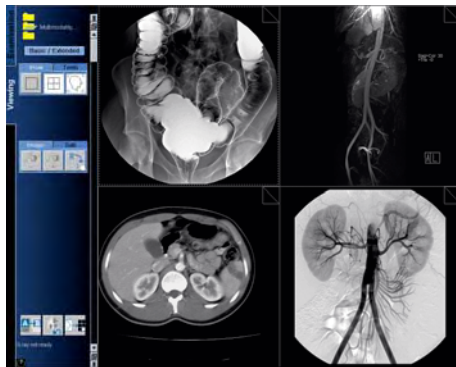

Full access to images from other modalities thanks to multi-modality viewing

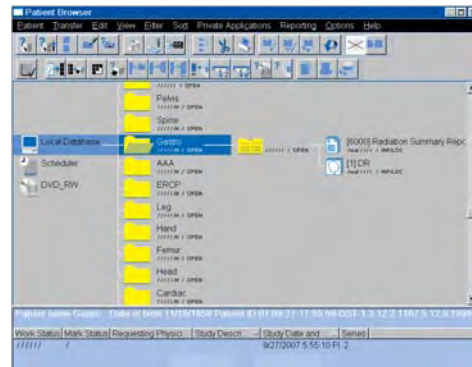

syngo user platform for uncompromised access to patient data



Excellent flexibility in data handling



apply

How to obtain decisively more precision and speed up the clinical workflow

The third dimension makes all the difference

In trauma and orthopedic surgery, the precise identification and repositioning of fractures and the accurate placement of implants is of highest importance. In many cases, common 2D projection does not offer enough information for precise control, which may result in painful post-traumatic complications for the patient and in the need for second interventions. With its capability of generating CT-like slices and even 3D volumes in real time, ARCADIS Orbic 3D provides the ultimate answer to even most delicate placement tasks, reduces the rate of second interventions, and revolutionizes the entire workflow. All processes and results can now be checked during the

intervention, and the physician can always react directly. At the same time, x-ray exposure for both patient and staff is considerably reduced.

Intraoperative 3D imaging with ARCADIS Orbic 3D covers a vast range of applications. It is ideally suited to enhance precision and safety in interventions in the following body regions:

- bones and joints of the upper and lower extremities
- cervical, thoracic, and lumbar spine
- pelvis and hip
- maxillo-facial

Intraoperative 3D imaging with ARCADIS Orbic 3D leads to more precision in surgery and thus redefines the entire workflow

Conventional C-arm



ARCADIS Orbic 3D

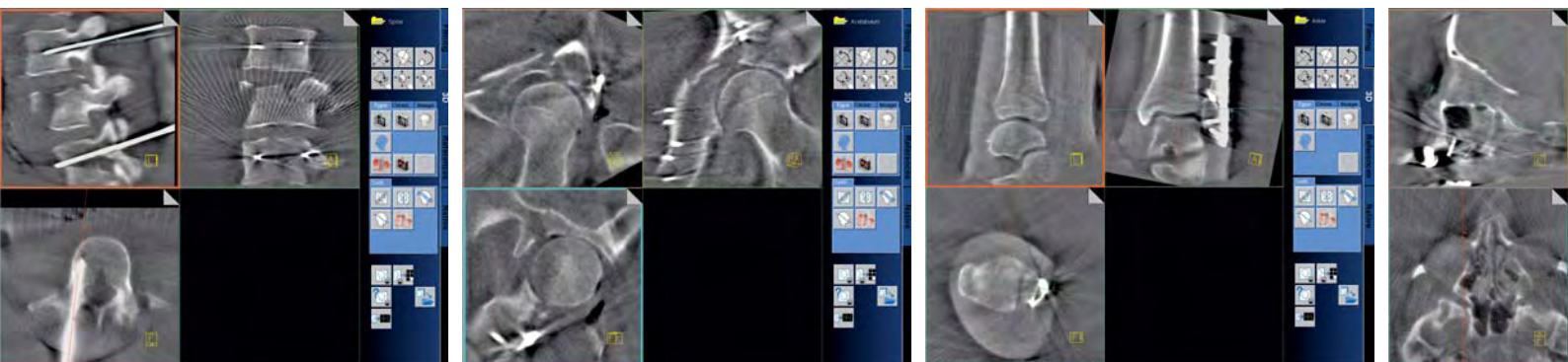
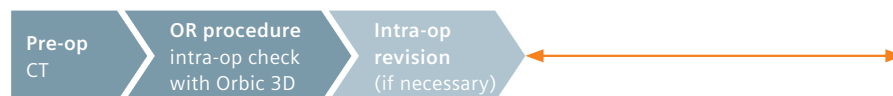

Spine

Acetabulum

Ankle

Head

Amazingly easy: the steps to 3D images during interventions

- A dedicated 3D dialog intuitively guides the user through the entire 3D setup. The C-arm position is visualized relatively to the table, and the scan protocol is clearly described.
- The body region to be imaged is positioned in the isocenter with the help of laser light localizers.
- A radiation-free manual test run ensures that the unit will not collide with other objects during the following automated scan.
- The automatic 190° scan is initiated via the foot switch.
- ARCADIS Orbic 3D requires only 30 seconds for a complete standard quality scan with 50 2D images in 1K² resolution – or 60 seconds for a high quality scan comprising 100 2D images.
- The 3D dataset, a cube covering a volume of approximately 12 cm x 12 cm x 12 cm, is progressively generated throughout the scan and displayed on the right monitor as MPR slices in coronal, sagittal, and axial views.
- The correct position of the reconstructed dataset can be monitored during the scan.
- The complete 3D image data is available immediately after the scan.
- The 3D image data can alternatively be displayed in VRT (Volume Rendering Technique), which allows for easiest orientation in the dataset.
- Clinicians can review, individually align, and evaluate the reconstructed 3D dataset on the right monitor in all spatial directions. The corresponding 50 or 100 individual 2D images are displayed on the left monitor.
- For comparison purposes, a dataset acquired before an intervention and another one acquired during the intervention can be reviewed simultaneously. 3D Dual Monitor Support allows for synchronized parallel scrolling in the two datasets.

Intraoperative 3D imaging for outstanding control during interventions

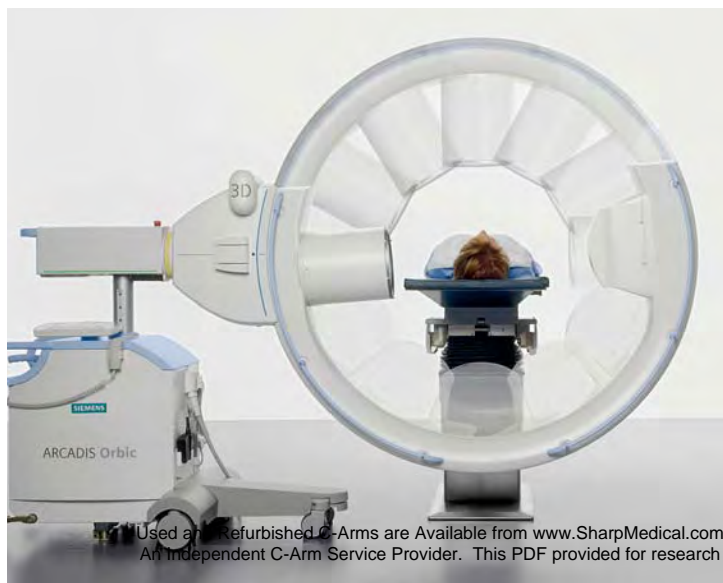
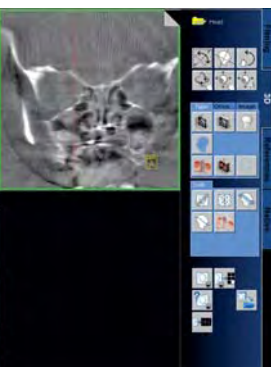

3D Dual Monitor Support for synchronized parallel scrolling within two datasets

How to gain utmost confidence and perform most delicate interventions

Get maximum orientation by combining images from other modalities with intraoperative 3D data

With the 3D Image Fusion package you gain even more confidence: Even image data generated at different times and with different modalities can be spatially aligned and visualized. Hence, you are able to combine preoperative images from CT and MR with intraoperative 3D data acquired with ARCADIS Orbic 3D, e.g., combine soft-tissue information from MR with high-contrast and skeletal information from ARCADIS Orbic 3D, or combine various intraoperative 3D images, which is especially useful for interventions like tumor resection. Various registration and alignment parameters allow for high flexibility and thus ensure effortless alignment of the images.

VRT images acquired during interventions

VRT (Volume Rendering Technique) is a sophisticated algorithm that allows for highly precise, 3D visualization of the acquired datasets. This makes orientation significantly more convenient and contributes to unprecedented precision and safety during interventions.

Merging of image data from other modalities and intraoperative images with 3D Image Fusion

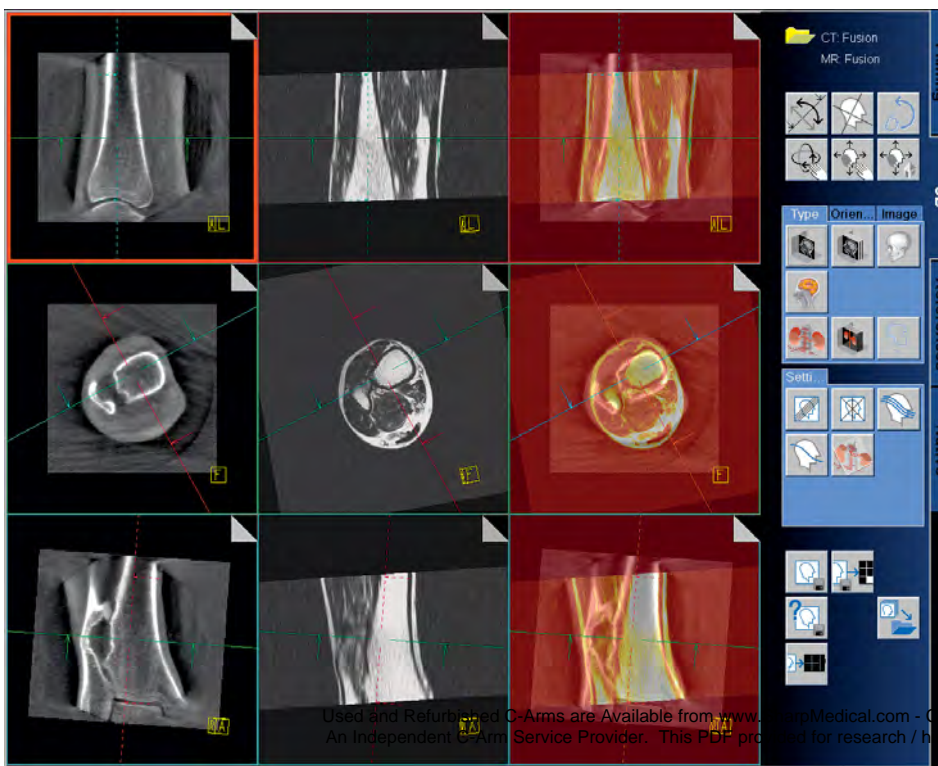

Visualization of 3D datasets with VRT

Precision with 3D navigation

Surgical 3D navigation does not only increase safety and precision especially in minimally invasive surgery. It also reduces the average time required for interventions and, by continuous visualization of the instruments, is an effective dose-saving measure. ARCADIS Orbic 3D features NaviLink 3D, an integrated, truly digital 1K² navigation interface with automatic image transfer that is compatible with the navigation systems of all leading manufacturers.

After the 3D scan, NaviLink 3D transfers the 3D image data in full 1K2 format along with the spatial coordinates to the navigation system without any further processing. Hence, manual alignment of the anatomy to the 3D images is no longer required, the accuracy of the surgical navigation is increased considerably, and the clinical workflow is further optimized. In addition, 3D image data acquisition can be repeated to account for any anatomical changes during surgery.



NaviLink 3D, the interface to navigation systems of leading manufacturers

Increased precision in minimally invasive surgery through 3D navigation

How to employ cutting-edge technology and achieve maximum convenience

Appealing, well thought-out, and easy to handle

The system trolley of ARCADIS Orbic comprises a multitude of improvements designed to facilitate everyday work. With its footprint of only 73 x 65 cm, it sets a new benchmark for space saving design and advantageously accommodates the limited space in most ORs. Moreover, its lightweight and compact design, ergonomic handles, centralized footbrake, and foldable monitors all contribute to an appreciable plus in maneuverability.

It's the details that count most

The trolley has been greatly improved for even higher user-friendliness and best maneuverability in tightest environments and under busiest working conditions. Input devices such as keyboard and mouse are always in direct reach, and the top of the trolley also features intelligent detail solutions like a drawer for CDs, DVDs, and the quick guide. All network and video interfaces are easily accessible placed at the left and at the right side of the trolley

for direct connections without any cable chaos. The x-ray indicator on top of the monitor support guarantees best visibility from all directions, which contributes to optimum dose care for all staff. To round out the multitude of beneficial improvements to your daily work, ARCADIS Orbic also offers EMotion, the onboard sound system that can be connected to an MP3 player, which makes working with ARCADIS Orbic an even more enjoyable experience.

Highest flexibility in monitor positioning

The monitors may be adjusted vertically, and they may be rotated by 180° to reduce the distance to the operation table considerably. To support this, the rear side of the trolley is kept totally cable-free for easiest cleaning – a design feature that is complemented by the unique cable-free C-arm. Hence, ARCADIS Orbic is the only system worldwide that does not expose any cables near the sterile field.



The trolley offers high user-friendliness and best maneuverability even in tightest environments and under busiest working conditions



Onboard sound system for an enjoyable environment

Clarity of orientation

The cleverly devised color code, for example, is a uniquely easy-to-understand and efficient means of orientation providing for quick and precise positioning of the C-arm. Each moving direction of the C-arm is represented by a color-coded measurement scale, which corresponds to the color of handles and brakes. Moreover, electromagnetic brakes for every moving direction support fast, precise, and effortless positioning considerably. An integrated laser light localizer furthermore indicates the focus with reduction of fluoro time.

Smart solution for transport and protection

In addition to the comprehensive adaptability the monitors offer during operations, they can be folded for transport and parking. Foldable monitors are a major contribution to safe transport of the system thanks to an unobstructed view, and also provide a very functional monitor protection solution in parking situations.

An intelligent investment for years to come

Exceptional performance and high versatility backed by comprehensive service options make ARCADIS Orbic a future proof investment of outstanding value. Alongside, the comprehensive service options available for ARCADIS Orbic guarantee highest uptime and utilization rates. Thanks to Siemens Remote Services, your system is proactively monitored and parameter deviations can be detected before problems occur. Remote diagnosis allows us to identify defective parts and to accelerate their delivery, thereby keeping repair times to a minimum.

The unique customer care solutions from Siemens help you get the most from your investment. From the moment of your purchase, Siemens surrounds you with an array of programs and support that enables the continuous development of your skills, productivity, and technology. Increase profitability. And take patient care to the next level.



Intelligent detail solutions and space-saving design make working at the trolley a most comfortable experience

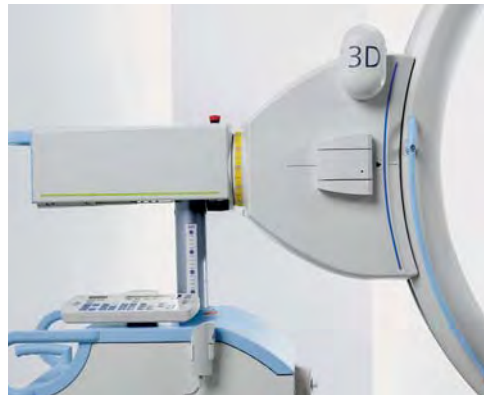

Each moving direction of the C-arm is represented by a color-coded measurement scale



The monitors can be folded for transport and parking

The information in this document contains general descriptions of the technical options available and may not always apply in individual cases.

The required features should therefore be specified in each individual case at completion of contract. Siemens reserves the right to modify the design and specifications contained herein without prior notice. Please contact your local Siemens sales representative for the most current information.

Original images always lose a certain amount of detail when reproduced.

In the interest of complying with legal requirements concerning the environmental compatibility of our products (protection of natural resources, waste conservation), we recycle certain components. Using the same extensive quality assurance measures as for new components, we guarantee the quality of these recycled components.

Please find fitting accessories:
www.siemens.com/medical-accessories

Local Contact Information

In USA

Siemens Medical Solutions USA, Inc.
51 Valley Stream Parkway
Malvern, PA 19355-1406 USA
Phone: +1 888 826 9702

In Japan

Siemens-Asahi
Medical Technologies Ltd.
Takanawa Park Tower
3-20-14, Higashi-gotanda
Shinagawa-ku
Tokyo 141-8644
Phone: +81 3 5423 8510

In Asia

Siemens Pte Ltd
The Siemens Center
60 MacPherson Road
Singapore 348615
Phone: +65 6490 8182

In Germany

Siemens AG
Healthcare Sector
Karlheinz-Kaske-Str. 2
91052 Erlangen
Phone: +49 9131 84-0

Global Business Unit

Siemens AG
Medical Solutions
Special Systems
Henkestr. 127
DE-91052 Erlangen
Germany
Phone: +49 9131 84-0

Global Siemens Headquarters

Siemens AG
Wittelsbacherplatz 2
80333 Muenchen
Germany

Global Siemens Healthcare Headquarters

Siemens AG
Healthcare Sector
Henkestr. 127
91052 Erlangen
Germany
Phone: +49 9131 84-0
www.siemens.com/healthcare

Legal Manufacturer

Siemens AG
Wittelsbacherplatz 2
DE-80333 Muenchen
Germany

www.siemens.com/healthcare